

CALCULATING LOADABILITY LIMITS OF DISTANCE RELAYS

Cesar Rincon, Joe Perez P.E., René Midence

Cesar Rincon, Entergy Corporation, USA, crincon@entergy.com

Joe Perez P.E., SynchroGrid LLC, USA, jperez@synchrogrid.com

René Midence, ERLPhase Power Technologies, Canada, RMidence@erlphase.com

Keywords: Distance relays, Mho and lens circles, loadability limits.

Abstract

Over the years, different methods have been used in order to avoid problems with load encroachment, and each method presents its own set of advantages and disadvantages. Regardless of the method used, each relay will have a maximum “loadability limit” that will cause the relay to operate under high load conditions. Therefore, it is important for the relay engineer to understand and take time to calculate the maximum loadability limits of the relay so as to avoid settings that will be susceptible to load encroachments. This technical document focuses on concepts, definitions and calculations to find the maximum loadability limit of a distance relay with mho and lens characteristics.

Introduction

Typically, distance relays protect transmission lines from power system faults by using the method of step distance protection. This method uses the line impedance as the basis to form zones of protection and each zone is calculated by a predetermined percentage of the line impedance. The impedance setting will establish the relay’s impedance characteristic, which is graphically displayed as circles or quadrilaterals in the R-X plane. A distance relay is capable of detecting faults, indicated by a drop in the impedance of the line (when the observed impedance is inside the relay’s defined impedance characteristic).

The load flowing through a transmission line also appears as impedance to the distance relay, and is typically called “load impedance”. As the power load on the transmission line increases, the load impedance decreases, and as the power load of the transmission line decreases, the load impedance increases. During steady-state or normal conditions, the load impedance is large enough that it remains far enough from the relay’s characteristic shape. In some situations, however, the power load of the line is sufficiently large that it reduces the load impedance to a point that encroaches on the relay’s characteristic shape. As a result, the distance relay identifies the encroachment as a fault and consequently trips the line out of service. This is a highly undesirable operation because a heavily loaded line has been taken out of service when no real fault exists.

Over the years, different methods have been used in order to avoid problems with load encroachment, and each method presents its advantages and disadvantages. Regardless of the method used, each relay will have a maximum “loadability limit” that will cause the relay to operate under high load conditions. Therefore, it is important for the relay engineer to understand and take time to calculate the maximum loadability limits of the relay so as to avoid settings that will be susceptible to load encroachments.

This technical document focuses on concepts, definitions and calculation on how to find the maximum loadability limit of a distance relay with mho and lens characteristics.

Apparent Impedance and Power Quantities

A distance relay measures the voltages and currents provided by a transmission line’s instrument transformers. Then, the current and voltage phasor representation is obtained and its sequence components are calculated at the relay location. The positive sequence impedance is then calculated using the positive sequence voltage and current values. The measured or apparent impedance can be plotted in the R-X diagram and checked to see whether the impedance is inside one of the zones of protection. Although the apparent impedance is not a good way to detect faults from load flow and

fault resistance conditions, it is a good way to detect load conditions [6]. At any given load, the apparent impedance values seen by the relay can fluctuate depending on the state of the line load, and impedance values can vary.

In some instances, such as high line loads and power swing conditions, the fluctuation of voltage and current may cause the load impedance to overlay or penetrate on the zone protection characteristics (mho, quad). If load impedance reaches the maximum loadability limit of the relay, an undesired tripping operation will be caused. It is important, therefore, to know the limit of the relay for different types of load conditions. However, we must first understand, in practice, the relationship between the load of the line and its impedance.

Since relays measure voltage and current values, power factor can also be calculated. As a result, apparent (S), real (P) and reactive (Q) power can be derived from current and voltage measurements.

R-X and P-Q Relationships

The power delivered by a transmission line is usually given as real power (MWs), reactive power (MVARs), and apparent power (MVA). We can then use these values to calculate the R and X coordinates and represent the same three-phase balance system in the R-X diagram. The relationship between the three power quantities with R and X is given below.

$$R = \frac{VLN^2 * P1\phi}{P1\phi^2 + Q1\phi^2} \quad (1)$$

$$X = \frac{VLN^2 * Q1\phi}{P1\phi^2 + Q1\phi^2} \quad (2)$$

The position for the R and X coordinates in the R-X plane depends on the direction of power and the power factor. For example, consider the one line diagram shown in **Figure 1**.

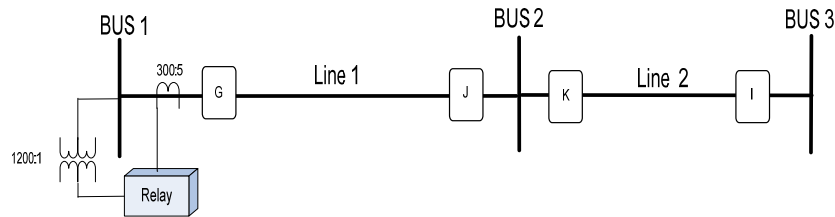

Figure 1: Three bus system-one line diagram.

If the direction of real and reactive power is from bus 1 to bus 2, the R-X coordinates are located in quadrant I. If the direction of real power is from bus 1 to bus 2 and the reactive power is from bus 2 to bus 1, then the R-X coordinates are located in quadrant IV. **Figure 2** shows the P-Q and R-X relationships for all four quadrants. We can observe that unity power factor is achieved when the value of jX equals zero.

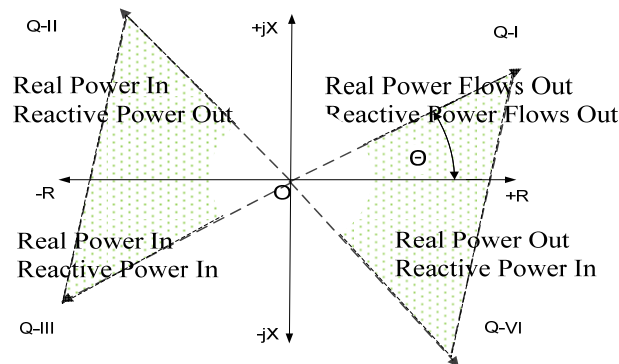

Figure 2: Power flow direction and power factor

This means that the system is purely resistive and that the current and voltage waveforms are in phase. In a real power system, a unity power factor is not practical; a power factor lower than 1 is found due to the capacitive and reactive elements. For most power systems, the power factor angles range from zero to +/- 40 degrees [1]. This means that the R-X values calculated from the P-Q values are bounded by the power factor angle (Θ).

The shaded area represents the apparent load impedance, and it can be seen that the line load impedance can occur in any of the four quadrants.

Line, Load and Relay Impedances

Transmission lines are usually protected by step distance protection using the mho or quadrilateral relay characteristic with three or four zones of protection. Each zone of protection is based on a percentage of the line impedance, which varies depending on the philosophy and criteria of each utility. However, zone 1 is usually 80%, zone 2 is 120% and zone 3 is 150% of the protected line impedance. Some relay manufacturers use zone 3 in the reverse direction, but for this application, zone 3 will be in the forward direction.

Figure 3 shows a oneline diagram with a distance relay protecting line 1. The diagram also shows the difference in distance for each zone of protection. Applying criteria for each zone's coverage areas yields:

$$\text{Zone 1} = 66.5\angle 75^\circ * 80\% = 53.2\angle 75^\circ \Omega$$

$$\text{Zone 2} = 66.5\angle 75^\circ * 120\% = 79.8\angle 75^\circ \Omega$$

$$\text{Zone 3} = 66.5\angle 75^\circ * 150\% = 100\angle 75^\circ \Omega$$

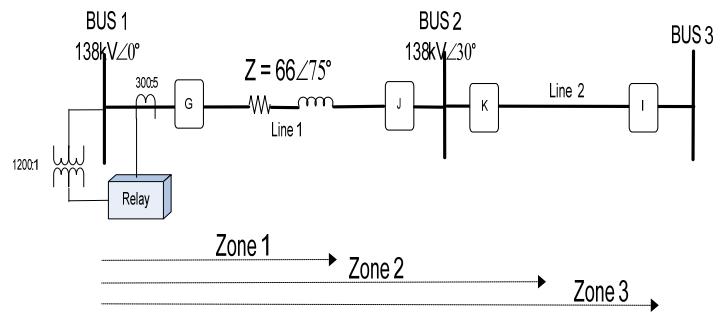

Figure 3: Step distance protection

The R-X diagram is one of the best tools a relay engineer can use to visualize the location and behaviour of the impedances. As a result, we can plot the line, load and relay impedances in the R-X plane to better visualize their location and proximity to each other. We will see how this can be done in the following sections.

Line and Load Impedances

The line impedance or Z_{Line} is the positive sequence primary phase-to-neutral line impedance. In a 60 Hz system, the impedance is about 0.8 ohms per mile. The angle (α) of this impedance depends on the conductor size and spacing, but generally it is in the range of 65-85 degrees for an overhead line [5]. The line impedance is plotted in the R-X diagram as shown in **Figure 4**. Once plotted, we can easily observe that the line $R+jX$ components can be derived by the familiar relationships:

$$R = Z_{Line} * \cos(\alpha) \text{ and } jX = Z_{Line} * \sin(\alpha) \quad (3)$$

As we discovered during the R-X and P-Q relationship section, the position of the load impedance in the R-X diagram depends on the direction of power. If we assume that the real and reactive power flows from bus 1 to 2, then the load impedance will be located in the first quadrant of the R-X plane.

We also know that the load impedance region is bounded by the power factor angle, which usually has a value of 0 to +/- 40 degrees. Take the example below where the load impedance value is located in the second quadrant of the R-X plane:

$$Z_{load} = -112.11 + j54.68 = 124 \angle 154^\circ \text{ Ohms} \quad (4)$$

For the purpose of simplification and explanation, let's assume that the real power is in the direction from bus 1 to 2, which will put the load impedance in the first quadrant. In this case, we will have:

$$Z_{load} = 112.11 + j54.68 = 124 \angle 26^\circ \text{ Ohms}$$

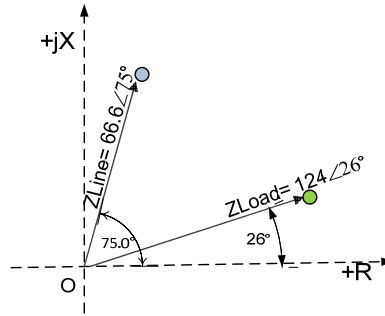

Figure 4: Line and load impedances

Relay Impedances - Zr

The relay impedances are the values that a distance relay uses for zones of protection. These values (settings) can be used with different types of relay characteristics, such as the mho, lens, tomato and quadrilateral. These relay characteristics form different shapes in the R-X diagram that allow for many different types of applications. Even though there are many different types of relay characteristics, the mho circle is the most common. Using the values for each zone of protection from **Figure 3** and Line 1, the mho characteristics for each zone are shown in **Figure 5**. We can observe that the diameter of each mho circle is based on the value of each zone of protection. In addition, the load impedance has been superimposed in the R-X plane with the mho circles in order to better visualize its locations.

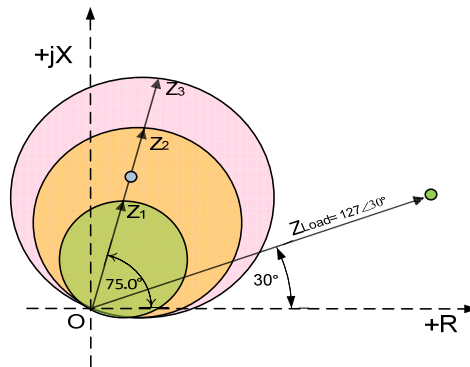

Figure 5: Line 1 relay mho characteristics

We know that during steady-state or normal system conditions, the load impedance remains constant and is high enough to keep it away from the relay zones of protection. From the graph, we can also see that the relay will trip as soon as the load impedance touches the outermost mho circle. So we must ask ourselves, what is the maximum power that the line can transport that causes the load impedance to touch or encroach into the outermost mho circle? In the next section, we will learn how to calculate these values.

Distance Relay Characteristics and Loadability Limits

The maximum loadability limit of a transmission line or conductor is bounded by the maximum current such conductors can carry before the conductor anneals and loses its elasticity. In most cases, calculations are performed that limit the amount of power a particular conductor can carry before the annealing point. A transmission line conductor's rating is based on static and dynamic properties that vary depending on the amount of load and ambient temperature. These ratings provide the operating and planning engineers with continuous, long-term and short-term emergency ratings. The short-term emergency rating will be the highest rating at which a transmission line conductor can be operated. The maximum ratings at which a particular line is operated have a direct impact on the maximum loadability limit of a distance relay.

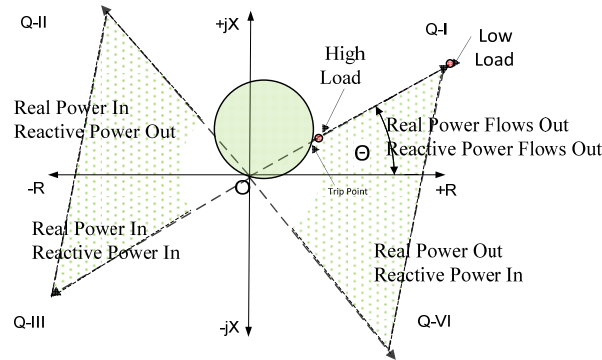

Figure 6: R-X diagram, superimposed mho circle and loadability limits

In previous sections, we have shown that the power load (MVA) of a particular line can be converted into R-X values as load impedance. If the load of a line is high enough, it is possible that the load impedance may encroach into one of the mho circles. This is because as load increases, the load apparent impedance decreases, moving it closer to the origin [1]. This relationship is shown in **Figure 6**.

We can see that during low load conditions, the load impedance is located farther from the mho circle and the R-X origin. However, when load conditions are high, the load impedance moves toward the origin until a tripping point is reached when the load impedance equals the maximum loadability of the relay, at a given power factor. Relay engineers must ensure that a distance relay does not trip under high load conditions in order to give system operators time to mitigate system problems. Therefore, a relay engineer must be able to calculate the relay loadability limits for different distance relay characteristics and power factor angles, which is the focus of next section. First, however, we must understand the elements of an mho circle.

The mho Circle

The mho circle is the most used relay characteristic for step distance protection. For this reason, we will put more emphasis on this type rather than others such as quadrilateral characteristics. The mho circle is composed of its impedance maximum reach, maximum torque angle and relay characteristic angle.

Impedance Maximum Reach (Z_r): The mho circle maximum reach is set by the impedance reach Z_r of the protective zone. As explained previously, these impedance reaches vary depending on the zone of protection such as zone 1, 2, 3 and 4. Each impedance value determines the diameter of the mho circle.

Maximum Torque Angle (MTA): The angle of maximum torque of a distance relay using the mho characteristic is the angle at which it has the maximum reach. For microprocessor relays, the MTA is the same as the positive sequence line impedance angle. The MTA or line impedance angle varies depending on the voltage level of the transmission line. For example, in the extra high voltage or EHV

transmission lines, the angles are higher and for lower voltage transmission and sub-transmission systems, the angles tend to be lower because the ratio of reactance to resistance is usually lower [4].

Relay Characteristic Angle: The relay characteristic angle (RCA) of an mho circle is 90° . For purposes of calculating the maximum relay loadability, the RCA is the angle whose vertices are made between the load impedance vector and the difference between the line impedance and load impedance vectors. The circular shape is formed when the Z_r vector and the RCA are fixed quantities. As the Z_{load} vector increases with higher power factors, the $Z_r - Z_{load}$ vector decreases, resulting in a locus that forms a circle.

From here, we can calculate the load impedance value for the points on the circle by varying the value of the power factor. Once the load impedance value is known for such points in the circle, the MVA value will be known, which will indicate the maximum MVA value at which the relay will trip.

Calculating the Maximum Loadability of a Distance Relay with mho Characteristics

The relay impedance zones of protection must be selected carefully in order to avoid load encroachment problems. The zone of protection with greatest risk is zone 3, since it is the mho circle with the greatest area and closest proximity to the load impedance. Zone 3 settings are certainly vulnerable to load encroachment conditions during high load and power swings conditions, which can cause the load impedance to travel towards the boundaries of the zone 3 mho circle and cause an undesired trip.

Since we now understand the basic principles that are associated with load impedances and mho circles, the calculation of the maximum relay loadability can now be performed. Since zone 3 is the zone with greatest risk of load encroachment, we will use zone 3 for our example.

From our line 1 example shown in **Figure 3**, zone 3 has a value of $100\angle 75^\circ \Omega$ primary. We want to know the maximum relay loadability that zone 3 will experience at different power factors, which is calculated in the steps below by using **Figure 7**.

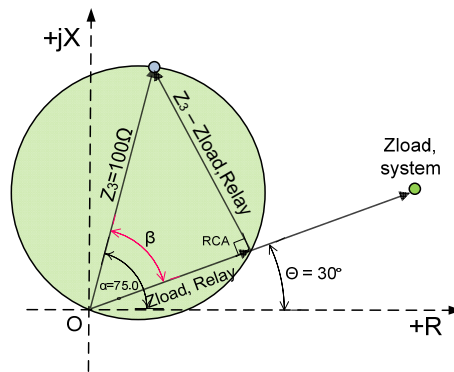

Figure 7: Mho shape and its components

1. Draw the zone 3 impedance vector in the R-X diagram.
2. Draw the load impedance vector at a specified power factor. For this example, $\theta = 30^\circ$.
3. Draw a right triangle forming the 90° relay characteristic between the load impedance vector and the difference vector that is made up of $Z_3 - Z_{load}$ (see **Figure 7**).
4. Calculate the interior angle β that is made between the load and line impedance vectors. This is done by subtracting the line impedance angle minus the power factor angle.

$$\angle \beta = \angle \alpha - \angle \theta = 75^\circ - 30^\circ = 45^\circ$$

5. Calculate the load impedance that the relay will experience at the specified power factor using right triangle properties:

$$\cos \beta = \frac{Z_{load}}{Z_3}$$

$$Z_{load, relay} = 100 * \cos 45^\circ = 70.71 \angle 30^\circ \Omega$$

6. Calculate the maximum loadability of the relay in MVA by:

$$S_{Relay} = \frac{kVLL^2}{Z_{load}^*}$$

$$S_{Relay} = \frac{138kV^2}{70.71 \angle -30^\circ \Omega^*}$$

$$S_{Relay} = 269 \angle 30^\circ MVA$$

Since $S = P + jQ$

$$S_{Relay} = 233 MW + j134 MVARs$$

Follow the same procedure and calculate the maximum loadability of the relay for different power factor angles, as shown in **Table 1**.

Table 1 Relay loadability limits for different power factors.

Power Factor Θ	S (MVA)	P (MWs)	Q (MVARs)
0°	734	734	0
15°	378	365	97
30°	269	233	134
45°	219	154	154
60°	197	99	170
75°	190	49	183
90°	197	0	197
120°	380	-190	329

It is convenient to plot the MVA loadability limit values in the P-Q diagram to distinguish “trip” versus “no trip” areas. This plot is shown in **Figure 8**, which emphasizes the amount of real and reactive power needed to trip a line based on zone 3 settings at different power factors.

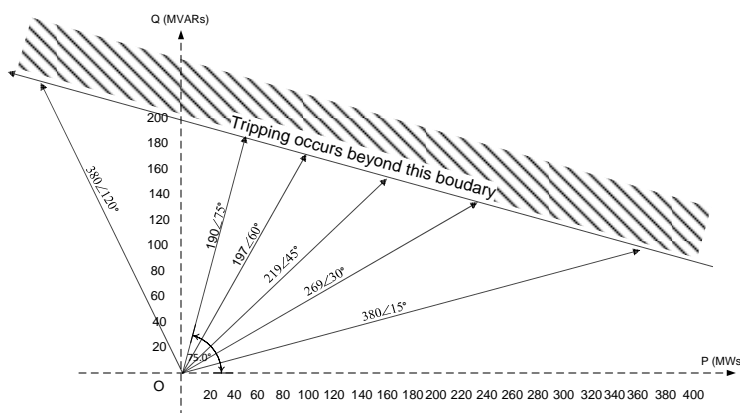

Figure 8: P-Q Diagram and Loadability Limits

It can be observed from table 1 and extrapolated from figure 12 that for line 1, operating at unity power factor, 734 MWs are required to trip.

Calculating the Maximum Loadability of a Distance Relay with Lens Characteristics

It might be necessary to change the characteristic shape of the impedance tripping zone to a lens shape. The lens characteristic reduces the zone coverage and therefore increases the amount of permissible load. However, relay engineers must keep in mind that by reducing the impedance coverage, the amount of coverage for resistive type faults is reduced.

The lens shape has a relay characteristic angle (RCA) that is in the range of $90^\circ > \theta > 120^\circ$. As the RCA increases, the impedance coverage area is reduced due to a narrower lens shape. In a similar manner, as with the mho circle characteristic with a RCA of 90° , we can calculate the maximum loadability in (MVA) of a distance relay that uses a lens characteristic.

As with the mho circle characteristic example, we will choose zone 3 for our calculations since this is the area of coverage with a greater risk to load encroachment.

The loadability is calculated as follows:

1. Draw the zone 3 impedance vector in the R-X diagram.
2. Draw the load impedance vector at a specified power factor. For this example, $\theta = 30^\circ$.
3. Choose a lens characteristic angle. This angle is formed between the load impedance vector and the difference between the zone 3 impedance and load impedance vectors. This is shown in figure 8. A lenticular shape is formed when the lens characteristic angle and zone 3 impedance vector are fixed quantities. The lenticular locus is formed when the load impedance vector changes as the power factor angle changes. For this example, the lens characteristic angle $\Phi = 120^\circ$.

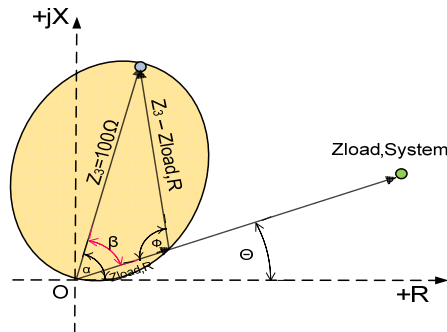

Figure 9: Maximum relay loadability and lens shape

Separate the inside triangle from the lens shape as shown in **Figure 10**. This allows us to see our impedance vectors and angles more clearly.

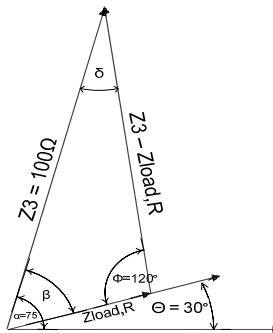

Figure 10: Applying the Law of Sines

Calculate the internal angle β .

$$\angle \beta = \angle \alpha - \angle \theta$$

$$\angle\beta = \angle 75^\circ - \angle 30^\circ = 45^\circ$$

Calculate the internal angles δ .

$$180^\circ = \angle\delta + \angle\varphi + \angle\theta$$

$$\angle\delta = 180^\circ - \angle\varphi - \angle\theta = 180 - 120 - 45 = 15$$

Calculate the load impedance vector (ZLoad) by using the Law of Sines. See figure 9.

$$\frac{a}{\sin(a)} = \frac{b}{\sin(b)}$$

$$\frac{Z_{load}}{\sin(15)} = \frac{Z_3}{\sin(120)}$$

$$Z_{load,R} = \frac{100 * \sin(15)}{\sin(120)}$$

$$Z_{load,R} = 30.0 \angle 30^\circ \Omega$$

Calculate the maximum loadability of the relay at the calculated load impedance and specified power factor of 30° .

$$S = kVLL^2 Z_{load}^*$$

$$S = \frac{138kV^2}{30.0 \angle -30^\circ}$$

$$S = 634 \angle 30^\circ MVA = 550 MWs + j317 KVARs$$

We can observe that by using the Lenticular characteristic, the amount of permitted load has been increased significantly compared to the rho characteristic with a value of 269 MVA. The reader is encouraged to perform a P-Q diagram as in the previous section to determine the tripping area of the relay for different power factor values.

NERC Considerations

Following the blackout of August 2003, The North American Reliability Council (NERC) has issued several considerations and documents that provide different guidelines that address zone 3 settings of distance relays and load encroachment. For example, NERC PRC - 023 recommends evaluating relay loadability at 0.85 p.u. voltage and a power factor angle of 30° . When these recommendations are used, the relay loadability limit is reduced from the values calculated in this document. As a result, the reader is encouraged to follow NERC standards when performing load encroachment calculations. In addition, the reader is advised to read the reference materials that cover this subject in more depth, and to learn about additional considerations that the relay engineer must be aware of before setting or employing load encroachment functions.

Conclusion

The loadability limits of distance relays are one of the most critical aspects of distance protection. This technical paper has presented the reader with valuable concepts explaining how to calculate the loadability limits of a distance relay and hopefully clarifies some of the ambiguity present in current literature. The relay engineer should be able to follow the steps in this paper (along with NERC recommendations) and be able to verify load encroachment problems before distance relay settings are applied.

References

- [1] T. Seegers, E. Krizauskas, et. al, Transmission Line Protective Systems Loadability, IEEE Power Engineering Society Power System Relay Committee Special Report, New York, NY; 2000.
- [2] C. R. Mason, The Art & Science of Protective Relaying, Wiley, John & Sons, Inc., 1956.
- [3] System Protection and Control Task Force of the North American Electric Reliability Council, "Methods to Increase Line Relay Loadability," September 2004. [Online] Available: http://www.nerc.com/docs/pc/spctf/Methods_to_Increase_Line_Relay_Loadability_6-7-06_%282%29.pdf
- [4] Maximum Torque Angle Application Guide. Retrieved July 27, 2011, www.selinc.com.cn/detail/FileDownload.asp?FileID=554.
- [5] "Transmission and Subtransmission Line Protection Application Guide", 1964, GET-7206A.
- [6] $Z=V/I$ Does Not Make a Distance Relay, Retrieved July 27, 2011, <http://www2.selinc.com/techprs/6022.pdf>.

Biography

Joe Perez is the owner of SynchroGrid LLC. Previously, he worked as Application Engineer for the relay and digital fault recorder products of ERLPhase Power Technologies, formerly NxtPhase T&D. He previously worked as a transmission engineer and a field application engineer, gaining experience in system protection projects and transmission system studies, including fault, power flow, and contingency analysis. Joe graduated from Texas A&M University in 2003 with a BSEE and has previously presented papers at WPRC, Texas A&M and Georgia Tech Relay Conferences. Joe is a registered professional engineer in the state of Texas and a member of PSRC, IEES, and PES. Joe resides in the Bryan/College Station area. He can be contacted at jperez@synchrogrid.com.

Cesar Rincon is the Lead Engineer (Relay Settings) for the areas of LA and TX in the Entergy service territory. He has worked in relay protection for the full range of power systems devices, including work in relay testing, acceptance testing and commissioning. His work also includes short circuit modeling and real time modeling/simulation. Cesar graduated from the University of New Orleans with a BSEE in 2005 and from Louisiana State University with an MSEE in 2008. He is registered in the state of LA and an active member of the IEEE.

René Midence (IEEE M'2007, SM'2009) is a Business Unit Manager at ERLPhase Power Technologies. He has over 25 years of experience in power systems, protection & control, SCADA, substation automation and substation LAN systems. He has contributed to the development and successful introduction to market of new state-of-the-art protection and control microprocessor based relays, and Ethernet switches and routers. He is a Senior Member of the IEEE with active participation in the development of IEEE Standards; he is member of the International Electrotechnical Commission (IEC) TC57 WG10. He graduated from the University of Honduras with a Bachelor of Applied Science degree in Electrical and Industrial Engineering.